



Loopo M1000 / M1500 / M2000 EN



Your safety is important to us -

Please review this Manual carefully for all safety warnings and take extra caution to keep both children and pets off the lawn when Robotic Mower is in operation.

Safety first..... (2)

Installation..... (13)

Quick reference..... (53)

Safety first

IMPORTANT!

READ CAREFULLY BEFORE USE

KEEP FOR FUTURE REFERENCE

- ① ***Warning decal definitions***
- ② ***Safety warnings & precautions***
- ③ ***Safety features***



Do not allow children to use or operate the mower.
Children must be supervised at all times.

1

Warning decal definitions

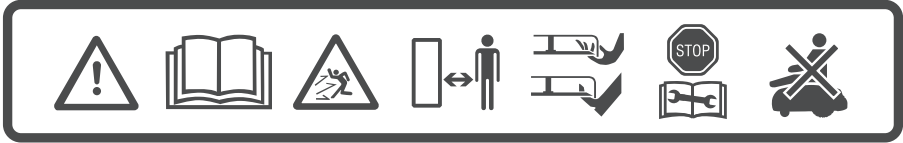

1 2 3 4 5 6 7

1. This is a dangerous power tool. Exercise care when operating it and follow all safety instructions and warnings.
2. Read Safety Instructions carefully before operating your mower.
3. Be careful of thrown objects during operation.
4. Keep a safe distance from the mower while it is operating. Keep people, especially children, pets and bystanders away from the area where the mower is operating.
5. CAUTION – Do not touch the rotating blade. Keep hands and feet away and do not lift the mower from the ground.
6. Activate the disabling device before working on or lifting the mower (see Section 3.b).
7. Do not ride the mower.



Do not dispose of the mower or any of its parts as unsorted municipal waste. They should be collected separately.



This product conforms to applicable EU directives.



This symbol indicates that the mains electricity is double insulated

2

Safety warnings & precautions

A. Before you begin

1. Read this Safety Manual carefully before operating the mower to become familiar with its controls and proper use.
2. Never allow children, persons with reduced physical, sensory or mental capabilities or lack of experience and knowledge or people unfamiliar with these instructions to use the machine. Local regulations may restrict the age of the operator. You are responsible for accidents or for harm to other people or their property.
3. It is your responsibility to inform your neighbors about the risks, and that it is forbidden to enter your lawn while the mower is operating.
4. If your lawn is open to the street and/or your neighbors, you must be present during the mower's operation to prevent others from accessing your lawn. Alternatively, you must protect/fence your lawn so that others do not access the mower during operation.

B. Preparations

1. Ensure the correct installation of the Perimeter Wire, as instructed.
2. Inspect periodically the area where the mower is used and remove all stones, sticks, cones, wires and other foreign objects.
3. Periodically visually inspect to verify that the blade is not worn or damaged. Replace a worn or damaged blade (Part No.MRK7003A/MRK7003W).

C. Operation

IMPORTANT SAFETY WARNING!

Do not leave the mower to operate unattended if you know that there are pets, children or people in the vicinity. Never mow while people (especially children) or pets are nearby.



1. Do not operate the mower if any safety feature or any part is damaged, worn or inoperable.
2. Keep hands and feet away from the cutting blade and other moving parts.
3. Always switch off the Safety Switch before lifting it or planning to operate any adjustments.
4. Never pick up or carry the mower while the motors are running.
5. Do not touch the blade before it has completely stopped rotating.
6. Do not use the mower for any purpose other than cutting lawn.
7. Keep all guards, shields, safety devices, and sensors in place. Repair or replace damaged parts, including decals.
8. Set the weekly program at times when there are no people on the grass.
9. Do not connect a damaged power cord to the supply, or touch a damaged cord before it is disconnected from the supply as it can lead to contact with live parts.
10. Keep the extension power cord away from the blade to prevent the mower from damaging it. A damaged power cord can lead to contact with live parts.
11. If the power cord becomes damaged or entangled during use, detach it from the mains by pulling the plug from the socket.
12. In the event of accident or breakdown whilst the mower is operating, immediately press the red STOP button.

D. Transportation

Within the working area:

1. Press STOP to stop the mower.
2. Use the Remote Control. (available as an accessory or via the mobile app) to drive it from one place to another.
3. In case of different ground height level, switch off the Safety Switch, and carry the mower by its carrying handle.

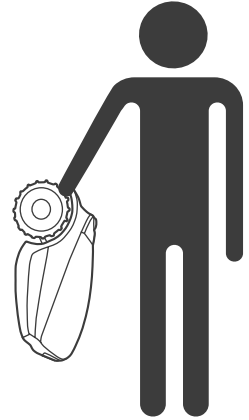

Over long distances:

When transporting your mower over long distances, switch off the Safety Switch.



IMPORTANT! It is recommended to keep the original packaging for shipping purposes.

E. Using the remote control (manual mowing)

1. Mow only in daylight or in good artificial light, and avoid operating on wet grass.
2. Do not operate the mower barefoot or wearing open sandals. Always wear substantial footwear and long trousers; always make sure of your footing on slopes.
3. Use extreme caution when reversing the direction of the mower towards you.
4. Always switch on the motor according to the instructions while standing away from the blade.
5. Do not mow manually in slopes greater than 15 degrees or where a firm footing is not possible.

F. Batteries

1. Do not open or damage the battery pack.
2. The Battery Pack contains electrolytes. In case of an electrolyte leakage from the Battery Pack, the following actions should be taken:
 - Skin contact: Wash the contact areas off immediately with water and soap.
 - Eye contact: Immediately flush the eyes with plenty of clean water for at least 15 minutes, without rubbing.
 - Get medical assistance.
3. Ensure that the battery is charged using the correct charger recommended by the manufacturer. Incorrect use may result in electric shock, overheating or leakage of corrosive liquid from the battery.

G. Maintenance and special instructions

1. Always switch off the Safety Switch before clearing blockage/checking/cleaning/working on the mower, or after striking a foreign object to inspect the machine for damage. Never attempt to service or adjust the mower while it is in operation.
2. In case of abnormal vibrations, stop the mower, switch off the Safety Switch and check for any damage of the blade. Replace a worn or damaged blade (Part No. MRK7003A/MRK7003W) to preserve balance. If the vibration continues, call for service.
3. Use heavy gloves when inspecting or servicing the blade.
4. Do not perform maintenance barefoot or wearing open sandals. Always wear suitable work shoes and long trousers.
5. Replace worn or damaged parts for your safety.
6. Use only original equipment and accessories. It is not permitted to modify the original design of the mower. All modifications are made at your own risk.
7. Ensure that only replacement cutting means of the right type (Part No. MRK7003A/MRK7003W) are used.
8. Maintenance/servicing/cleaning of the mower should be according to manufacturer's instructions.
9. Keep all nuts, bolts and screws tight to be sure the machine is in safe working condition.



WARNING!

When there is a risk of a lightning storm, disconnect the Perimeter Wire from the Base Station /Perimeter Switch and the Power Supply 230 V/120 V plug from the power outlet.

H. Product end of use

1. The mower and its accessories should be collected separately at the end of their life to prevent waste electrical and electronic equipment from ending up in landfill sites, and to protect and improve the quality of the environment.
2. Do not dispose of the mower or any other of its parts (including the Power Supply and Base Station) as unsorted municipal waste - they should be collected separately.
3. Ask your local distributor/dealer about return and collection systems availability.
4. Do not dispose of the battery pack in a fire, and do not place used batteries in your household trash.
5. The battery must be collected, recycled, or disposed of in an environmentally sound manner.

3 Safety features



WARNING!

Your mower is equipped with numerous built-in safety features. However, the mower is a hazardous device with a sharp blade, which can cause major injury to anyone who comes in contact with it. Therefore, it is absolutely forbidden to be on the lawn while the mower is working. Alternatively, halt the mower's operation when people (especially children) or pets are to stay or play on the lawn.

A. Child Lock

The Child Lock prevents unintended operation of the mower by an accidental press of one of the buttons. Only pressing two buttons in the right order will initiate the operation. It is required to activate the Child Lock feature if children under age 6 may come in contact with the mower.

B. Anti-Theft / Disabling Device

The Anti-Theft / Disabling Device system function will prevent anyone from using or driving the mower unless they have a valid code to enter. You will be prompted to enter a four digit code of your choice to use as your personal security code. It is highly recommended to activate this feature to prevent operation of the mower by children or people who are unfamiliar with the mower or not allowed to use it.

C. Lift Sensor

If the mower is raised from the ground during the blade's operation, the blade will stop rotating immediately.

D. Tilt Sensor

If the mower is tilted up towards a vertical position, the blade will stop immediately.

E. Obstruction Sensor

Your mower detects interfering obstacles in its way during operation. When the mower collides with an obstacle, it will stop the rotation of the blade immediately, will stop movement in that direction and reverse itself away from the obstacle.

F. Emergency Stop Button

Pressing STOP at any time during operation will stop the mower and the blade immediately.

G. Safety Switch

Switching off the Safety Switch will prevent any operation of the mower. It is required to switch it off before lifting the mower and before any maintenance is done.

H. Base Station / Perimeter Switch and Perimeter Wire

The mower cannot operate without a Perimeter Wire installed and activated through the Base Station/ Perimeter Switch. In the event the Perimeter Wire signal is turned off, the mower will stop operating.

***Let's get
started.
Can't wait
to mow your
lawn.***



Welcome to a friendly home

Congratulations on your purchase! You are just a few steps away from meeting your best team player. Very soon you will come to count on your new friend to do a perfect job.

The mower will independently depart from its Base Station on predetermined days and times, mow your lawn and return to base for charging.

A preinstalled perimeter wire sets the boundaries (a “virtual wall”) for your mower. It will be laid around the edges of your lawn, and objects that you want to protect.

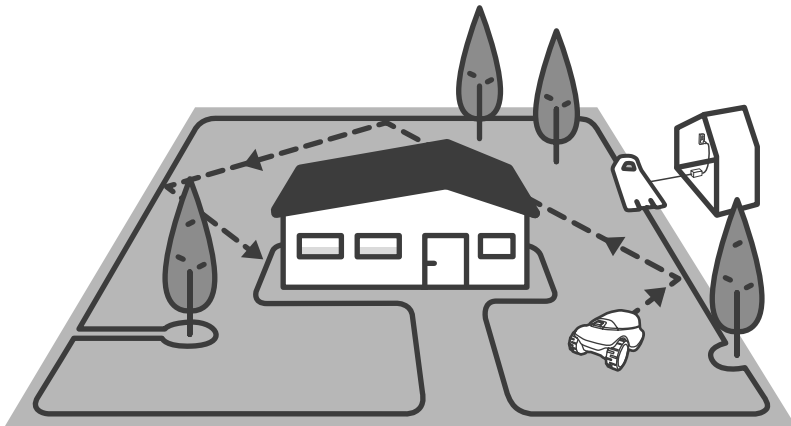

The mower moves randomly within its working area, as defined by the perimeter wire. This kind of random movement provides the perfect cut and ensures complete coverage of your lawn.

In addition, it centers itself on top of the perimeter wire to ensure accurate, flawless edging.

Good-looking lawns are achieved by consistent mowing, which is exactly what a robotic mower provides.

After following the clear installation instructions, you will be ready to enjoy your free time, while your new friend looks after your lawn.

So where are we headed?

Correct installation of your mower will ensure maximum results. This is what it takes to prepare mower to do a perfect job for you:

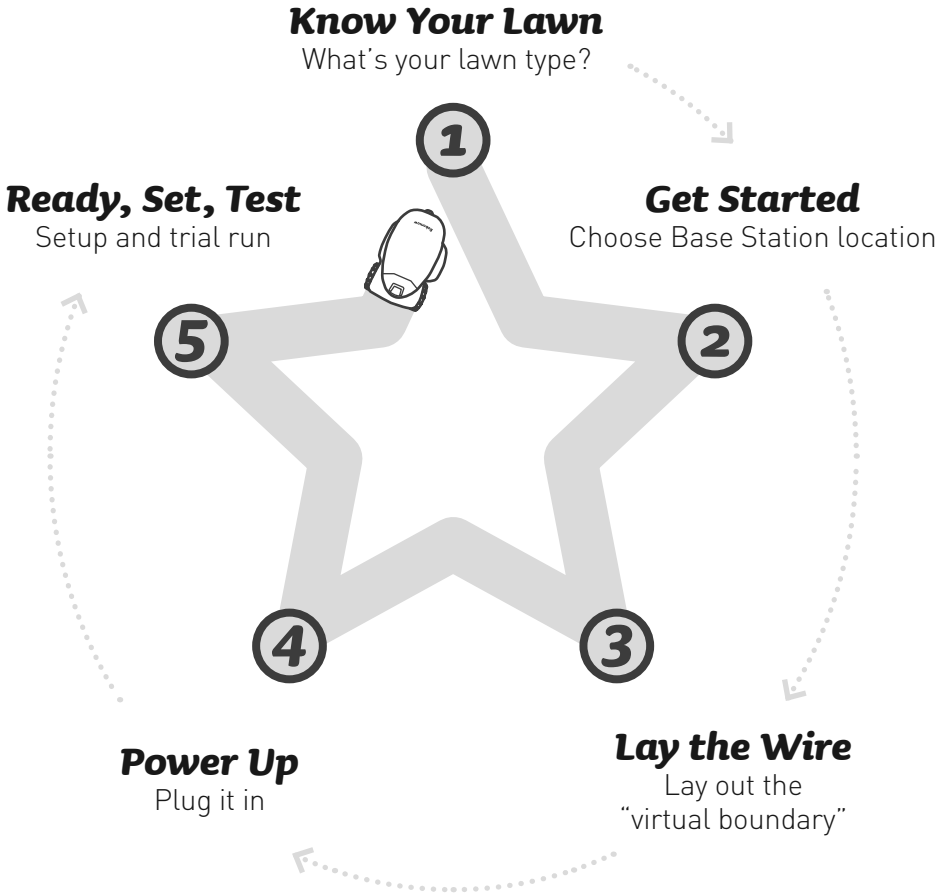

What's in the box

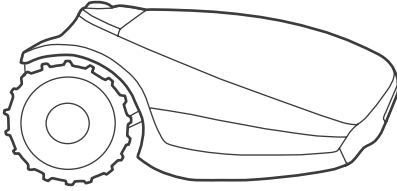

The product

Your new Robotic Mower

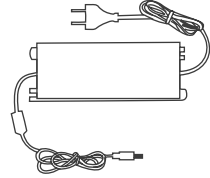

Power Supply

The power supply for charging of your mower

Base Station with Extension Cable

The Base Station is where the mower recharges itself. The 15m (50ft) low voltage cable connects the Base Station to the Power Supply unit

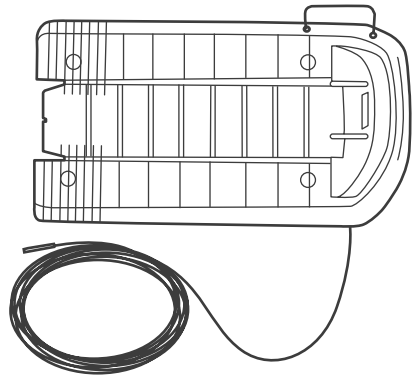

User Guide

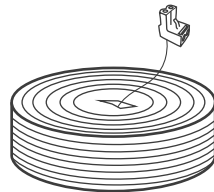

Perimeter Wire

Marks the working area for your mower



Blade Tool

For safe removal of the blades

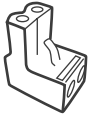

Spare Plot Connector

For connecting the Perimeter Wire to the Base Station

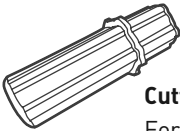

Cutting Height Extender

For an easier adjustment of the cutting height



Wire Connectors

For splicing the Perimeter Wire in case of a cut

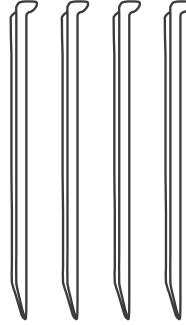

Base Station Stakes (x4)

For affixing the Base Station to the ground

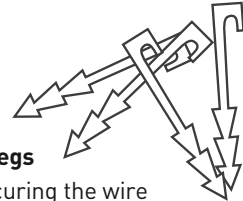

Wire Pegs

For securing the wire to the ground

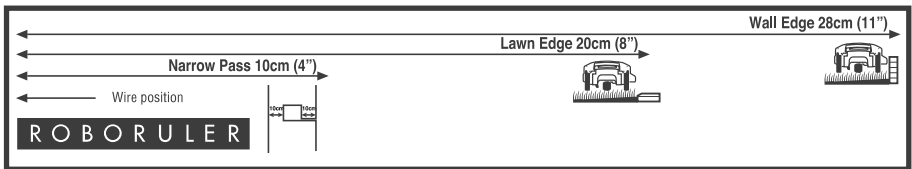

RoboRuler

For measuring the Perimeter Wire's distance from lawn's edge

Ready? Let's begin...

1 Know your lawn

Understanding your lawn will save you unnecessary mistakes and make the installation process easier and more straight-forward.

You can also skip some later sections in this manual that are not relevant to your lawn type.

So, what does your lawn look like?

Type A **Main Zone only**

Your lawn area is one continuous zone and all areas of the lawn are wide enough for the mower to navigate through (at least 2 m [7 ft] wide at its narrowest point).

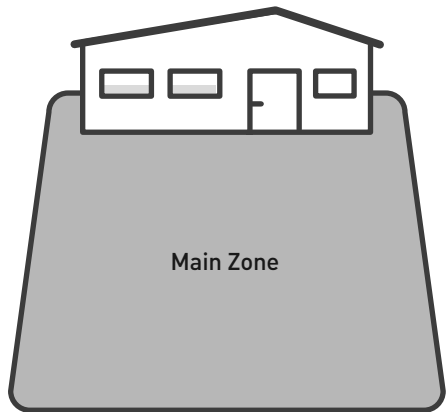

Type B **Main Zone + Sub Zone**

Your lawn consists of more than one zone. These zones are connected by a narrow passage (1-2 m / 3-7 ft wide). The mower can drive between these zones to mow the entire area.

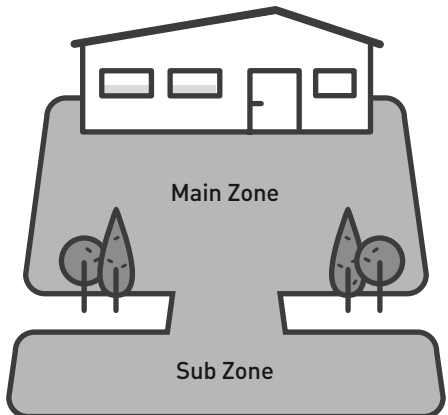

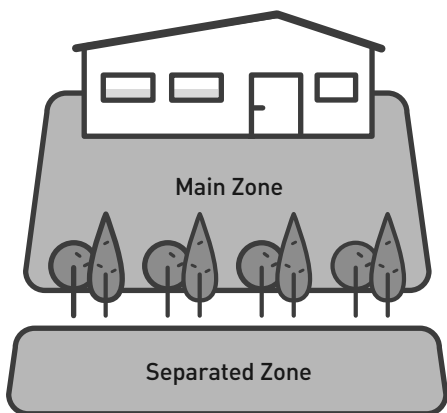

Type C **Main Zone + Separated Zone**

Your lawn consists of two or more zones that are not connected (separated by a fence, sidewalk, pathway or other obstacle). The mower cannot drive between these zones.

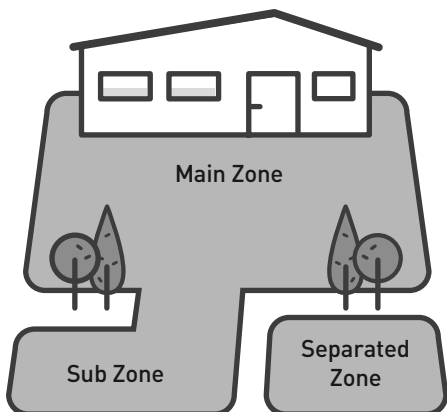

Type D **Main Zone + Sub Zone + Separated Zone**

Some areas of your lawn are connected to the Main Zone by a narrow pass (up to 2 m / 7 ft wide) and some areas are totally separated from the Main Zone by a fence, sidewalk, pathway or other obstacle, and the mower can't drive between them.

2 Get Started

Choose locations for the Base Station & Power Supply unit

The Base Station is where your mower recharges, and where the Perimeter wire starts and ends. In this installation step, you are going to determine a proper location for the Base Station.



TIP

The Base Station will be installed at a later stage, after the Perimeter Wire is in place.

Decide which installation type is right for you

There are two possible ways to install the Base Station:

Inside the lawn
Internal Installation

At a corner
External Installation

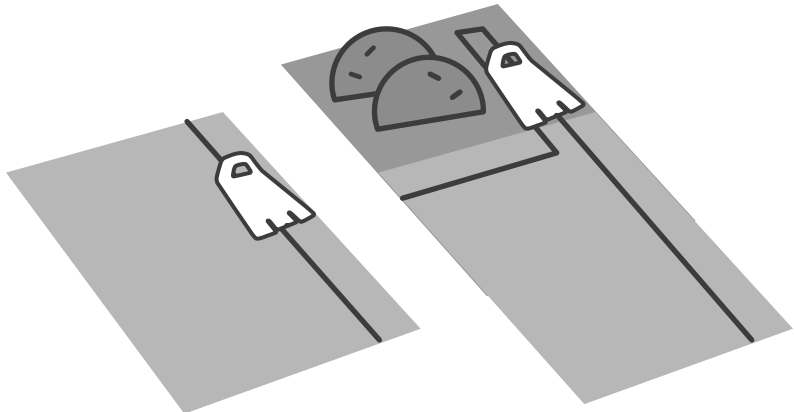

Follow simple guidelines to place your Base Station

Consideration A

Up to a max. of 15 m (50 ft) from a power outlet

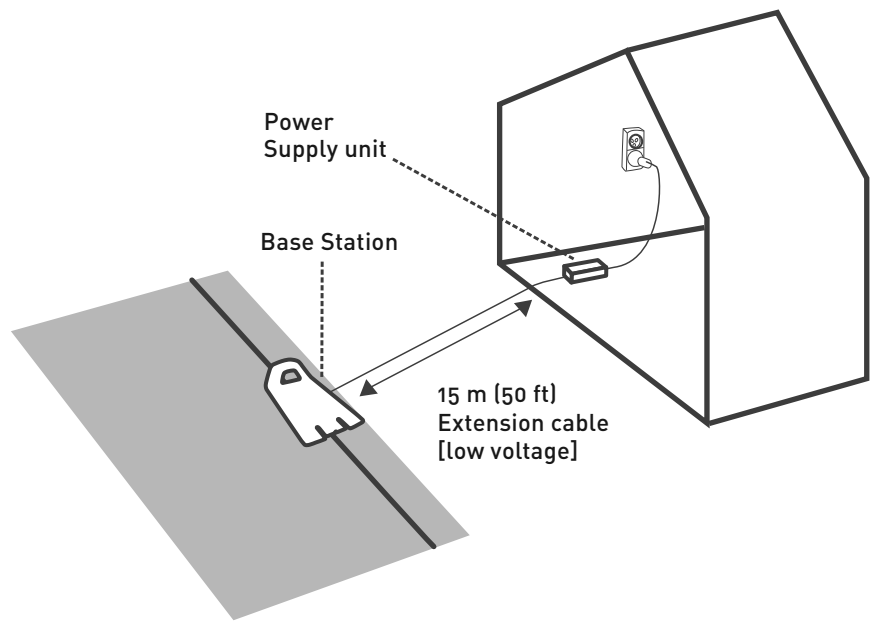

Consideration B

A min. of 1.5 m [5 ft] of straight wire in front of the base and a min. of 10cm (4 in) behind the base to allow smooth docking

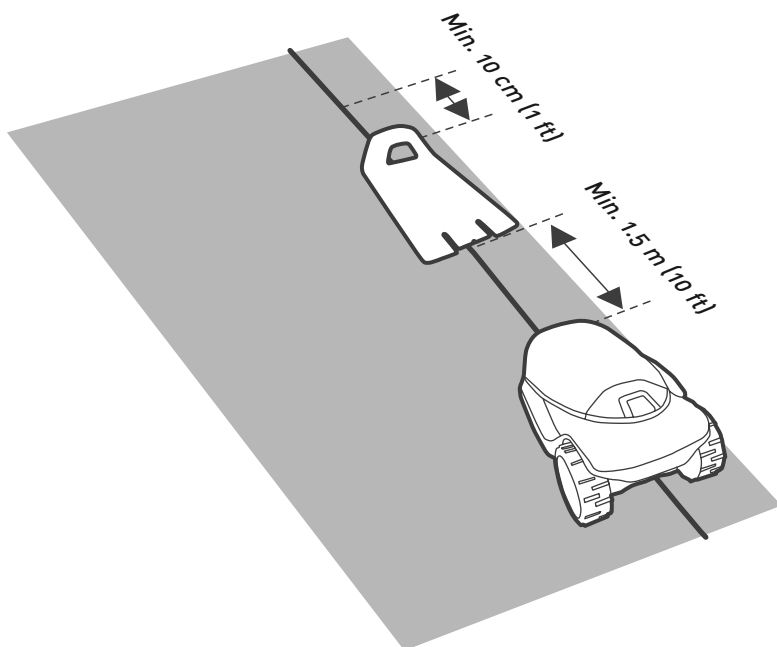

Consideration C

Make sure the ground is even and flat, and that there are no slopes

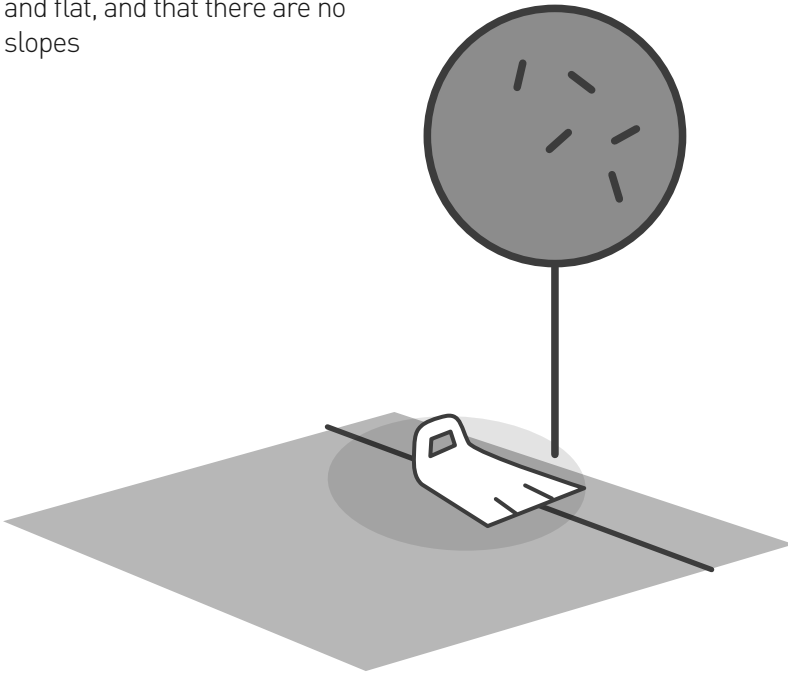

-
- If there are additional zones in your lawn, place the Base Station within the largest zone
 - In a flat and shady spot to extend battery life
 - Keep a distance of at least 1 m / 3 feet from sprinkler heads to avoid damaging the mower's internal components
-



TIPS

3 Lay the Wire

Lay the perimeter wire (“virtual boundary”), which defines the working area for the mower.

Now you’re ready to install the Perimeter Wire. Let’s take it step by step.



TIPS

- Have the mower’s package nearby.
- Be sure to cut your grass with your old mower one last time before you start wiring. This will make inserting pegs easier and help ensure that the mower doesn’t cut the wire.



WHAT YOU’LL NEED

- Hammer
- Small, flat & Phillips screwdrivers
- Combination pliers

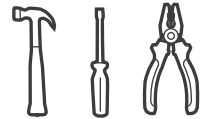

... A sunny day and a sunny mood :)

First things first: obstacles and slopes

Before you put a single peg into the ground, take note of any obstacles or slopes.

OBSTACLES



Soft Obstacles

Soft obstacles are flower beds, ponds or small trees. They need to be protected by creating Perimeter Islands.



Hard Obstacles

Obstacles that are vertical, rigid and higher than 15 cm (6 in), such as trees or telephone poles, do not need to be protected by the Perimeter Wire. The mower will bump into them and turn away..

SLOPES

Slopes along the edge

To ensure your mower doesn't slip off the lawn, especially when the grass is wet, the Perimeter Wire must exclude a slope along the edge of your lawn with an incline of over 10% - that is, 10 cm rise per 1 m [4 in rise per 3 ft].

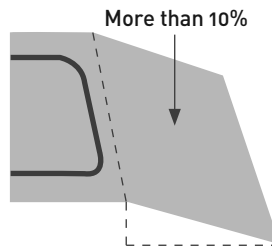
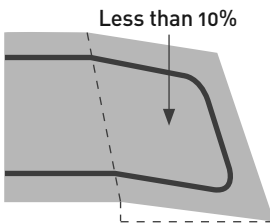

Slopes within the Lawn

Your mower can mow areas within the lawn with a slope of up to 35% [35 cm rise per 1 m/14 in rise per 3 ft].

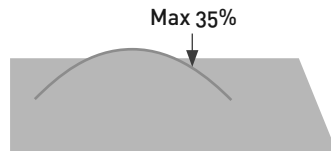

The slope is too steep if...

The mower tilts off the ground while climbing it. Exclude such slopes from the mower cutting area.



TIP

A. Make a good start

Before you begin, walk along the edge of your lawn and plan how to set up the Perimeter Wire. Take note of all obstacles and slopes.

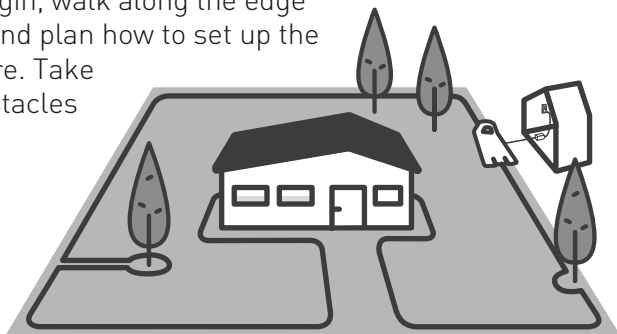

Pull out approx. 30 cm (1 ft) of wire through the hole in the spool's plastic covering and peg the beginning of the wire to the ground where you intend to install your Base Station.

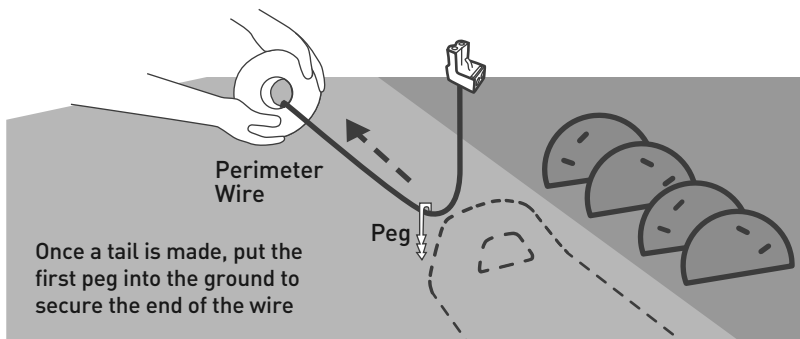

Start unwinding the wire counter-clockwise around the lawn, starting at the Base Station's location.

Lay it loosely along the perimeter as you walk along the lawn edge. If you get to any area/object that needs special care, make sure you carefully lay the Perimeter Wire as described in the following sections.

*A helpful video
is available
online*

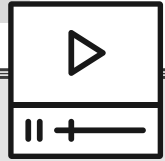

What if you prefer an External Base?

Please see the drawings below for proper instructions on how to lay the perimeter wire in this case.

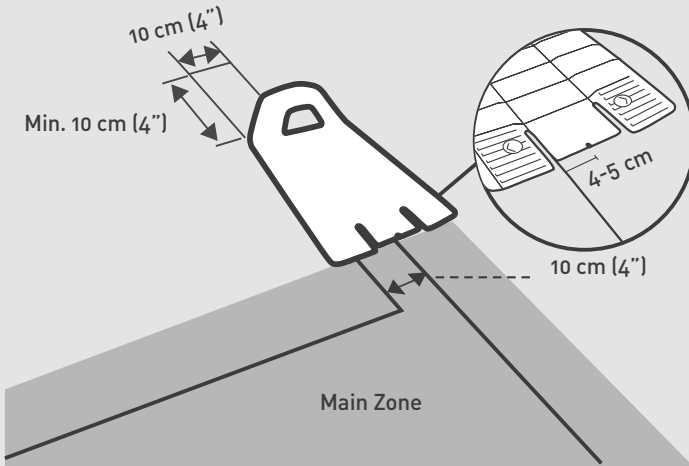

Note the straight wire section after the Base.



TIP

B. Maintain Proper Distance

The Perimeter Wire is secured to the ground by the pegs supplied with the product. Use the RoboRuler to determine the distances you should leave between the Perimeter Wire and the lawn's edge and obstacles.

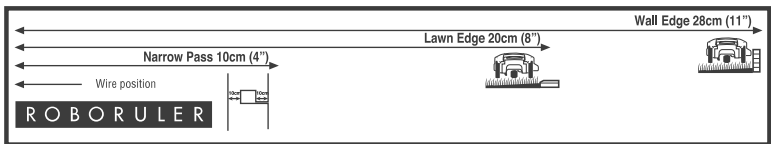
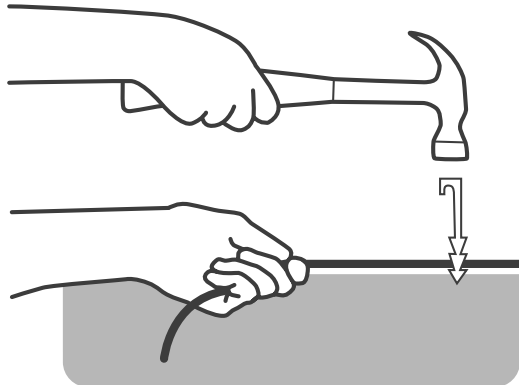

TIPS

- Insert pegs every few meters / feet and at corners. At this early stage, set a minimal number of pegs. You will insert all necessary pegs later.
- Pull the wire tight while hammering the pegs to their final depth in the ground.
- Take care not to damage irrigation pipes.

When the edge is flat or a drop, use the short distance of the RoboRuler.

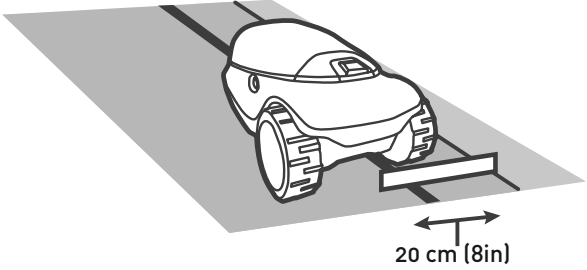

When the edge is a wall, use the longer distance of the RoboRuler.

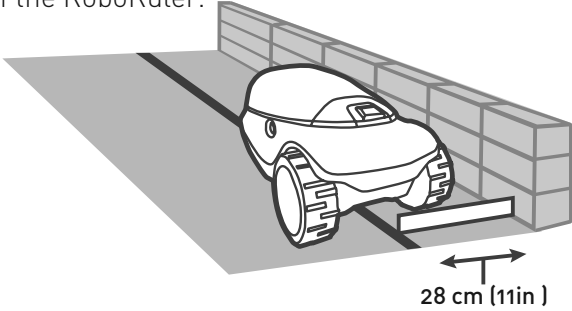

Leave a minimum of 1.2 m (4 ft) if the edge of the lawn borders water.

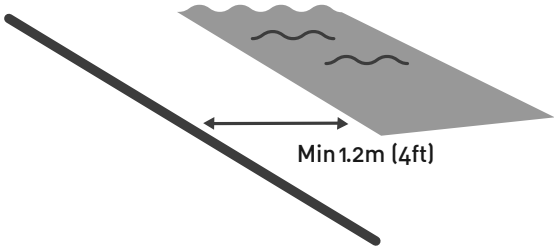



TIPS

- It is not necessary to bury the Perimeter Wire, though you may do so, up to 5 cm (2 in) deep.
- Burying the wire along exposed areas, such as pavements, is usually recommended.
- If additional Perimeter Wire is required in order to complete the setup, you can extend it using the waterproof Wire Connectors provided. (See Section “Splicing the Perimeter Wire” at the very end).

C. Make Smooth Turns

Maintain a 45° angle at all left-turn corners when laying the wire along the perimeter.

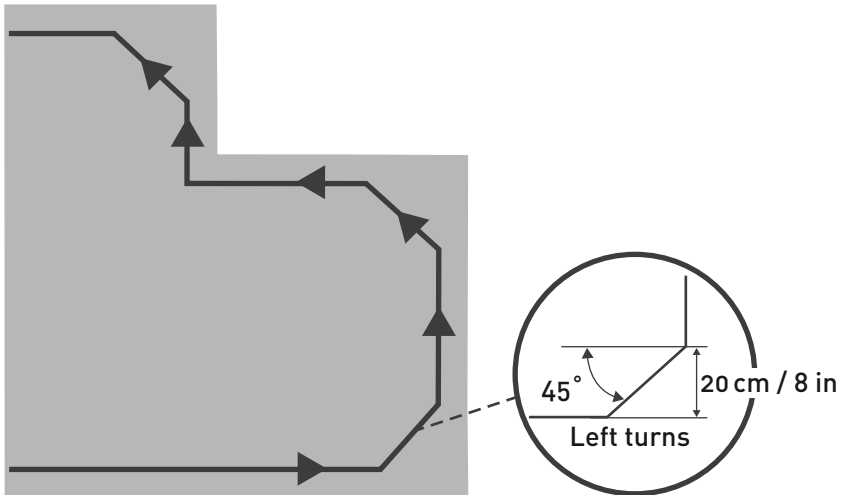

D. Protect Soft Obstacles

Objects such as flower beds, ponds, or small trees must be protected by setting Perimeter Islands.

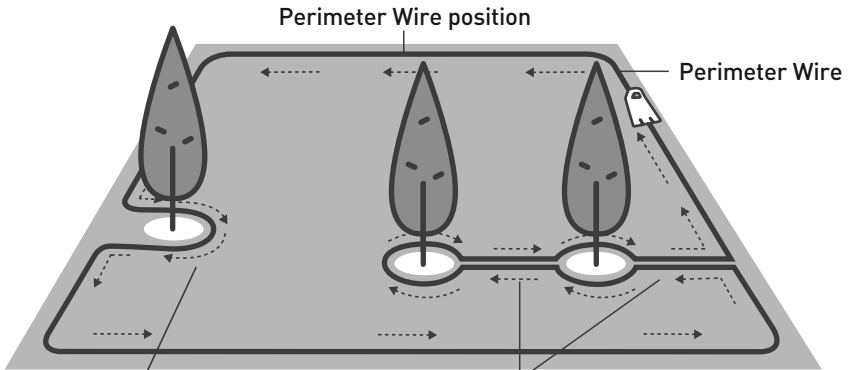

If the distance between an island and the perimeter wire is lower than 1 m (3.3 ft), make the obstacle part of lawn's edge.

Keep min. 1 m (3.3 ft) between islands; if obstacles are closer together, use one island

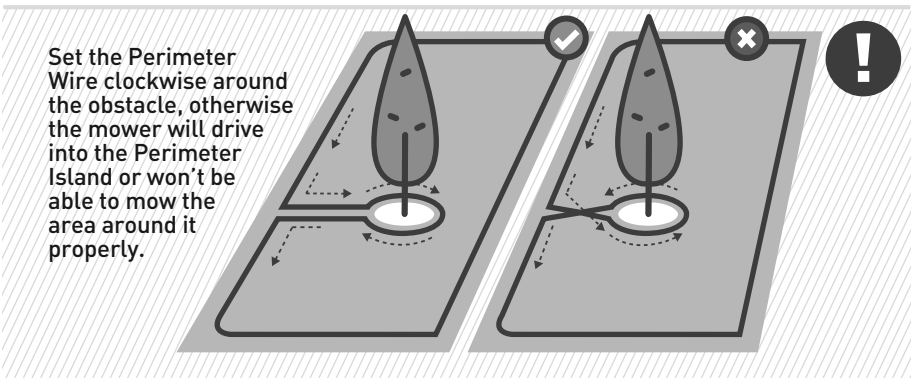

- Wires leading to and from an island should be fastened with the same peg
- Perimeter Islands should either be rectangular or round



TIPS

Recall Your Lawn Type

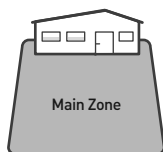

Type A
Main Zone only

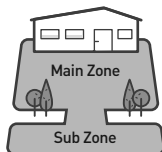

Type B
Main Zone +
Sub Zone

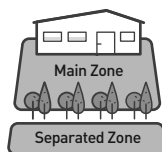

Type C
Main Zone +
Separated Zone

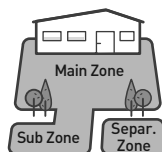

Type D
Main Zone +
Sub Zone +
Separated Zone

E. How to Wire a Sub Zone

Type B / Type D

*Don't have a Sub Zone?
Skip this section!*

A Narrow Pass connects the Main Zone with a Sub Zone. To allow your mower to drive through, it should be at least 1 m (3.5 ft) wide:

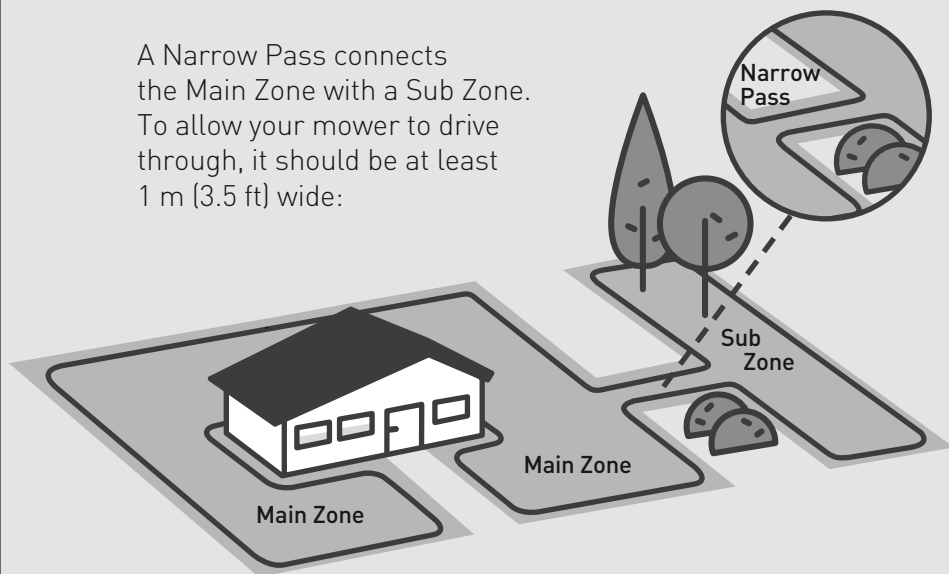

A helpful video
is available
online

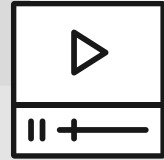

- If a Narrow Pass is shorter than 2 m [7 ft], set up only one square Perimeter Island in the passage
- Take care to wire Narrow Passes correctly to ensure that the mower doesn't cross into different zones spontaneously while mowing



TIPS

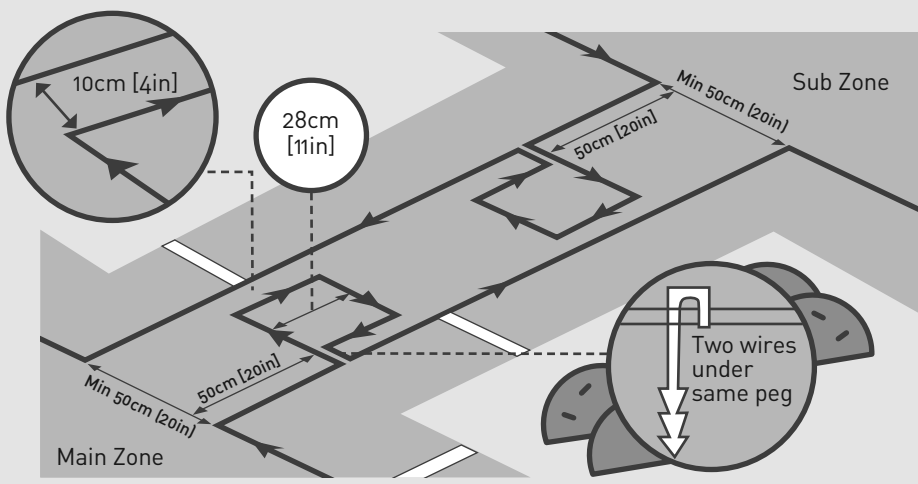

Narrow Passes should be firm, level, and smooth.

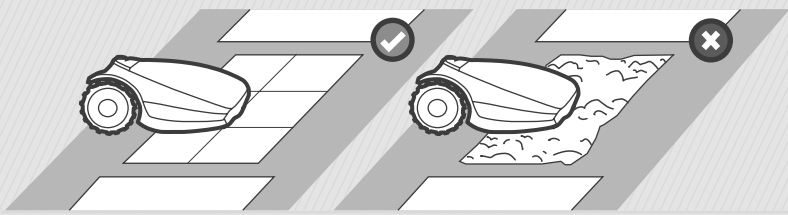

F. How to Wire a Separated Zone

Type C / Type D

*Don't have a Separated Zone?
Skip this section!*

If your Separated Zone is larger than 100 m² / 1100 ft², your mower won't be able to finish it in a single operation. Therefore, it is recommended to wire it separately and connect it to its own Base Station.

If your Separated Zone is smaller than 100 m² / 1100 ft², you can wire it in one of two ways.

OPTION 1

Extend the Perimeter Wire from the Main Zone, over the obstacle.

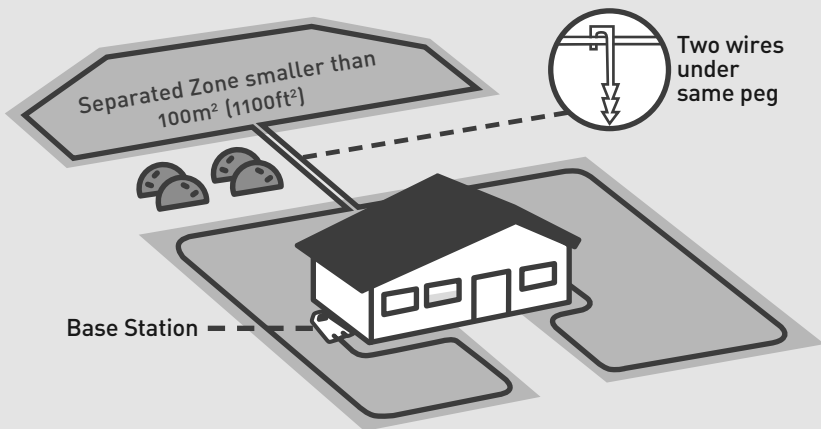

OPTION 2

Wire the Zone separately and connect it to a Perimeter Switch (optional accessory).

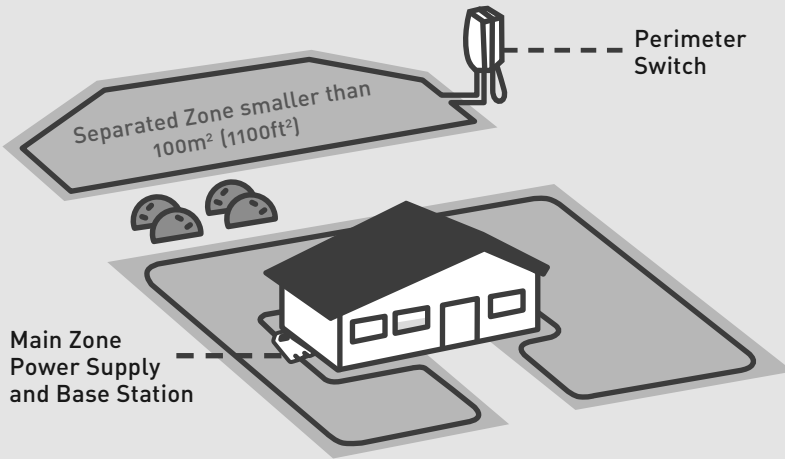

G. Complete Wire Setup

Once the Perimeter Wire has been laid completely, the two ends of the wire that meet at the Base Station should be joined together.



TIPS

- Use the same peg to fasten both tail ends of the wire to the ground
- Trim the ends so both wires are the same length

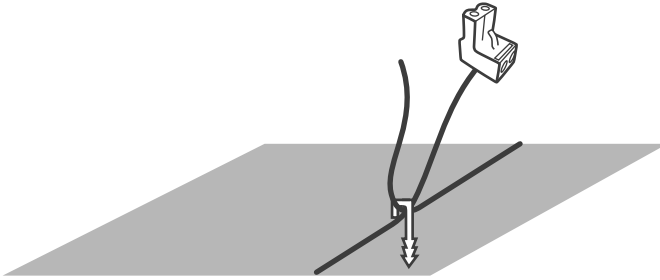

Make sure you twist the two wires together properly.

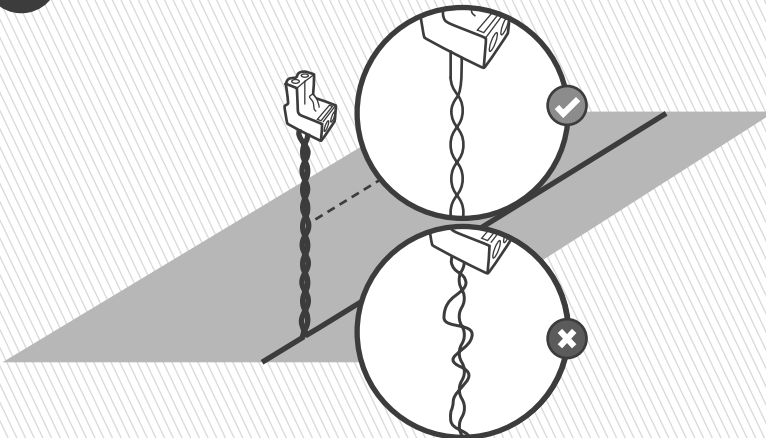

Strip back 5 mm (0.2 in) of insulation from the wire ends, insert the twisted wire into the connector and secure it using a small flat screwdriver.

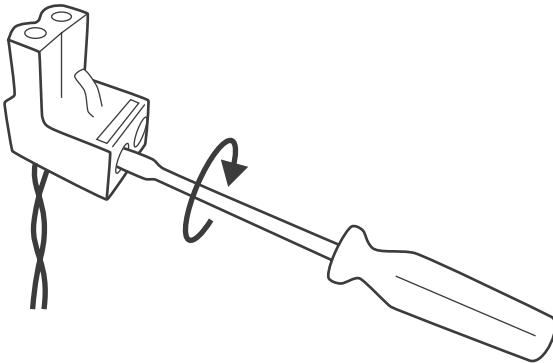
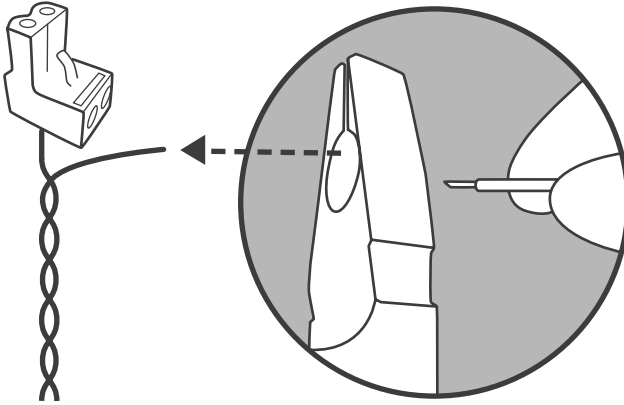

Yay! You've done the hardest part!

4 Power Up

Install and connect the Base Station

Place the Base Station in its planned location and align its **center** on the perimeter wire.

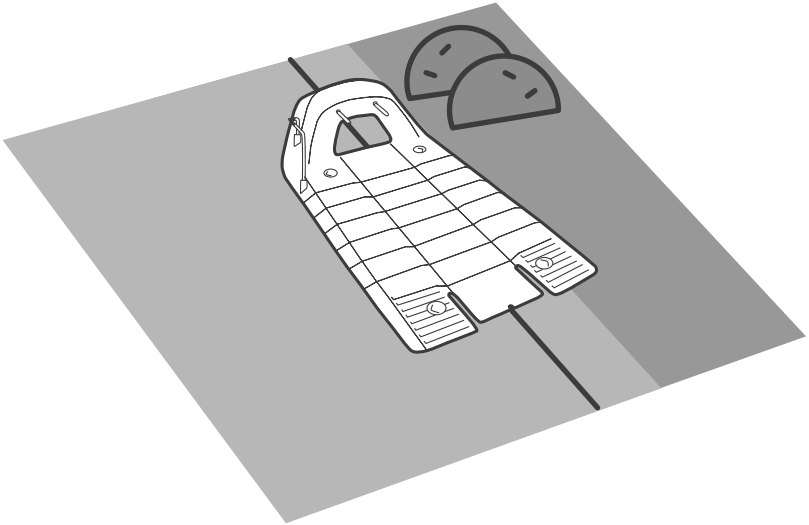

In case of **External Installation**, the Base Station should be placed in a small shift to the right, in order to allow smooth entry of the mower to the Base Station.

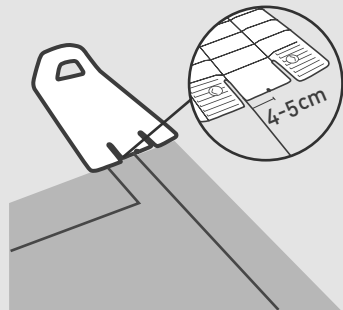

Connect the green connector of the perimeter wire to the Base Station as shown below, while keeping the right polarity.

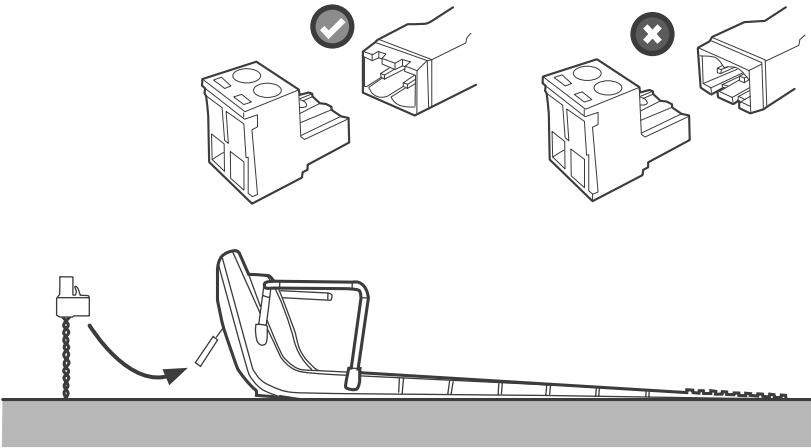

Insert only two stakes into the Base Station holes as shown.

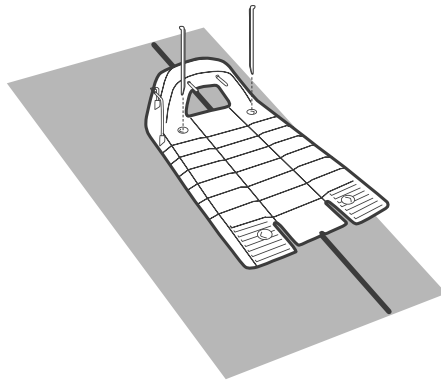

Be careful not to damage irrigation pipes when hammering down the stakes.



A. Connect the Power Supply unit



TIP

Consider the following in order to select a proper location for the Power Supply unit:

- Select a suitable location near a power outlet
- Position it outside the lawn perimeter
- A dry and sheltered location is preferable

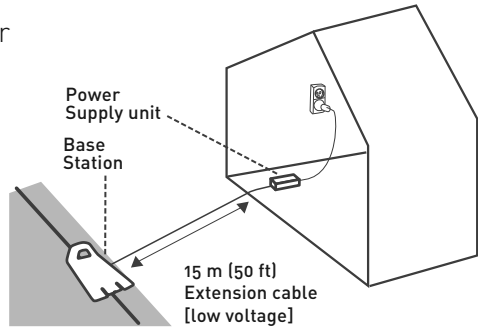

Connect the DC cable from the Power Supply unit to the 15 m (50 ft) extension cable.

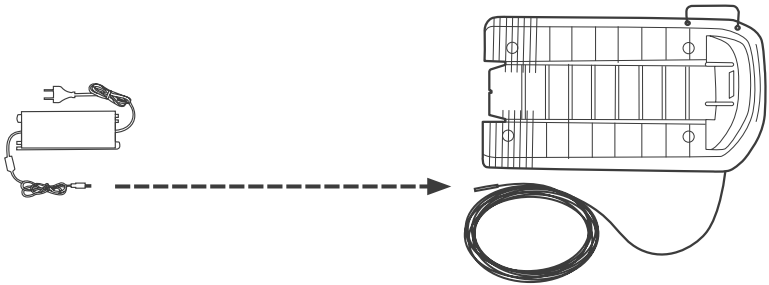

Make sure the connector is inserted the whole way up to the white mark.

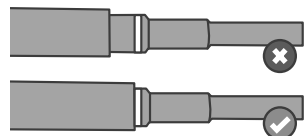
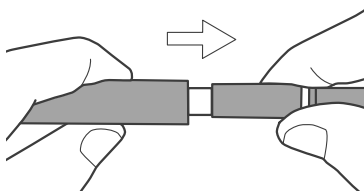

Connect the Power Supply unit to a regular power outlet.

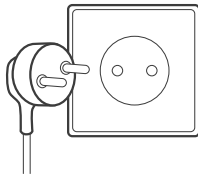

Now you should see the LED indication on the Base Station blinking green (if the mower is outside, or steady green (if the mower is inside the Base Station)).

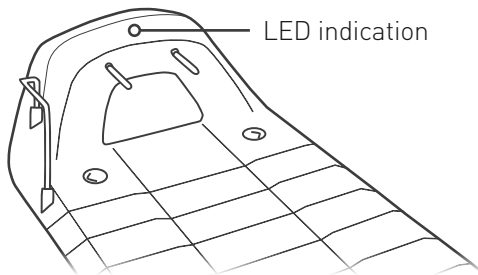

The Extension Cable from the Power Supply to the Base Station should be securely fastened to the ground! It should never present a tripping hazard. The Extension Cable should cross ONLY over soft surfaces (e.g., sidewalk, driveway) where it cannot be securely fastened.



5 Ready, Set, Test

Prepare your mower and give it a test drive.

Congratulations! Now you are ready to give it a whirl.

WHAT YOU'LL NEED:

- The mower
- Remaining Pegs
- Remaining Base Station stakes

... *A glass of champagne (or equivalent)*

A. Start up

There are a few things to do before your mower can start.

1. Adjust the mowing height (15-60 mm/0.6-2.4 in) by turning the cutting height adjustment knob:

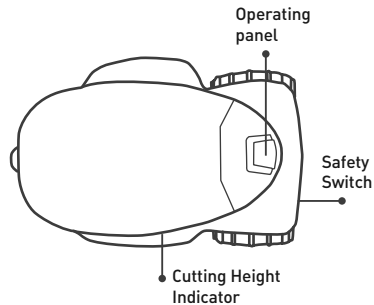

- To raise the cutting height, turn clockwise.
- To lower the cutting height, turn anticlockwise
- The cutting height is displayed at the side of the mower.

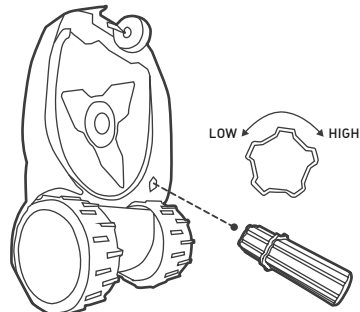

Always turn the safety switch off before adjusting the cutting height!



- Use the provided extender for an easier adjustment of the cutting height
- We recommend starting from the highest cutting height and gradually lowering it to the desired height after a few operations



TIPS

2. Switch on the Safety Switch.

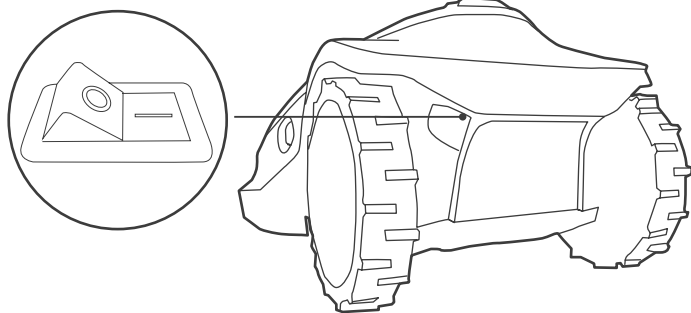

B. Set Basic Settings

Follow the instructions on the screen for a quick initial configuration.

Your mower has enough power to complete the configuration. Then, before mowing for the first time, you'll need to do a first-time charge that will take up 24 hours.



Using the operating panel:

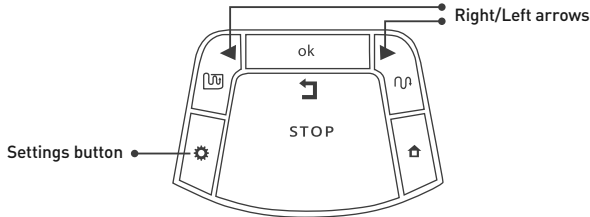

- Press the 'Right' or 'Left' arrows until your desired option is displayed.
- Press OK to select the value shown on the display.
- Press 'Back' (STOP) to go back or to cancel.

Choose Measurement Units and Formats:



	Area/Distance	Temp	Clock
EU	Meter	Celsius	24 Hours
US	Foot	Fahrenheit	12 Hours (AM/PM)

Set Day and Time:

- Scroll to set the Day and press OK to confirm
- Scroll to set the Time and press OK to confirm

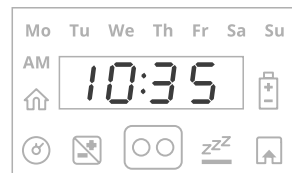

Set Main Zone Area:

Scroll to select an approximate area (EU-m²/US-ft²) for the Main Zone, where the Base Station is installed.

If an additional zone (Sub-Zone or Separated Zone) exists, do not include it in main zone's area (it will be set separately).



To restart the One-Time Setup process press and hold

TIPS **STOP + Settings + Left arrow** together for more than 4 seconds. This will invoke Factory Defaults (out-of-the-box settings).

C. Test Base Station Position

After setting the area, **U001** ("Test Base Station Position") is displayed:

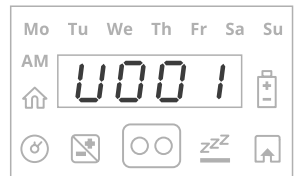

Place the mower on the lawn, 3 m (10 ft) in front of the entrance to the Base Station, facing the Perimeter Wire, and press OK to start the test.

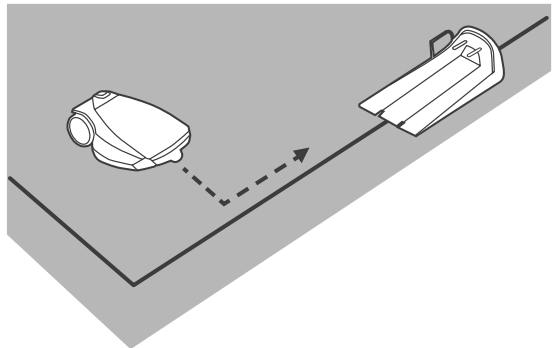

The mower will drive to the Base Station and enter it.

Next, it will drive out and wait in front of the Base Station and display **U002** ("Peg Base").



Insert the remaining two stakes into the Base Station. Press OK.

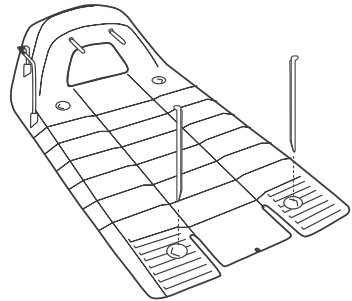

• **E3**

If the **E3** ("No wire signal") message is displayed, check that the Power Supply, extension cable and Base Station wires are all connected properly. Check for possible Perimeter Wire cuts.

• **U051**

If the **U051** ("Reposition Base Station") message is displayed, check that the Base Station is aligned with the Perimeter Wire. Move any obstacles preventing entry into the Base Station.

- Be careful not to damage irrigation pipes when hammering down the stakes.

D. Test Wire Position

When you see the message **U003** (“Test wire position”), it means your mower is ready to test the Perimeter Wire installation.

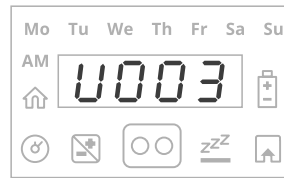

Press OK.

The mower will start driving. Walk alongside it as it tours the perimeter.

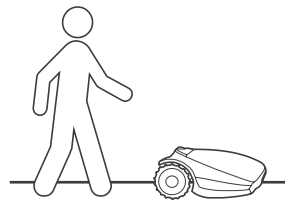

At the end of a successful tour, the mower will enter the Base Station and the setup process will be completed.

U052

If the **U052** (“Adjust wire”) message is displayed and the mower stops and drives backwards, move the wire slightly inward and press OK to continue the wire test.





TIPS

(Not applicable to models for lawns under 800 m² / 8600 ft²)

- When the mower completes its operation, it drives to the Base Station at a dynamic offset from the Perimeter Wire ("Near Wire Follow" mode). This is in order to prevent wheel tracks along the same path.

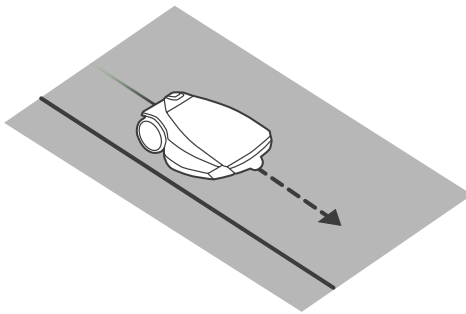

- After completing the Wire Position Test, it is recommended to test the mower in Near Wire Follow mode to make sure it works smoothly.
 - Press 'Settings' for more than 3 seconds and use menu P006 to initiate the test.
 - If the mower fails to complete the Near Wire Follow test smoothly, reduce the maximal allowed offset from the wire using menu P004
-

E. Finish Installing the Perimeter Wire

Insert the remaining pegs along the Perimeter Wire, approx. 1 m (3.3 ft) apart.

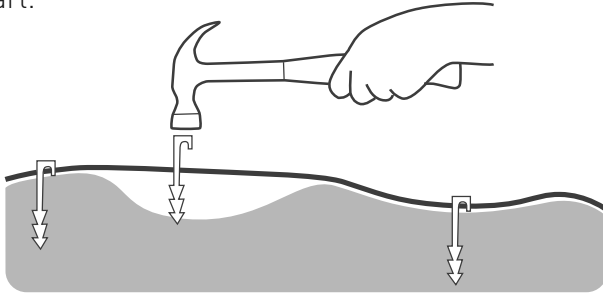

Hammer the extension cable into the ground so it's not a tripping hazard.

F. Charge your mower

Place your mower on the Base Station and let it fully charge before its first mow (up to 24 hours). Once it is fully charged, it will depart automatically according to its mowing schedule.

- The Safety Switch should be set to 'On' during charging
- Don't touch the blades
- Never mow when people, especially children or pets, are nearby
- Make sure the lawn is clear of debris



Don't worry if your lawn looks patchy for the first few days. It will even out after the first few mows!



TIP

Adding Sub Zones

If your lawn has additional zones and they are connected to your main zone by a narrow passage (we call such zones “Sub Zones”), you need to tell your mower how to get to these zones.

To do this, press “Settings” on mower’s panel for more than 3 seconds. Scroll to get to menu P022. The table below describes how to use this menu to program a Sub Zone.

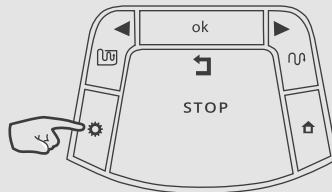

Menu	Setting	Description
P022	Add Sub-Zone	<ul style="list-style-type: none"> • Upon entering the menu A1/A2/A3/A4 is displayed. This is a name of the next available Sub Zone, which you can program. Press OK • If the mower is currently not at the Base Station, a message U044 (“Place the mower in the Base Station”) will be displayed. Place the mower in the Base Station and press OK. • The mower will travel along the perimeter wire to the Sub Zone on its own. • When the mower is at least 5 m (16 ft) inside the Sub Zone, press STOP and select the area size of the Sub Zone. Press OK. • The distance to the Sub-Zone’s entry point can be updated later through menu P023

Are there any Separated Zones?

For lawns that have completely noncontiguous Separated Zones, the area size of these zones needs to be set separately.

To do this, press “Settings” on the mower’s panel for more than 3 seconds. Scroll to get to the menu P014.

The table below describes how to use this menu to program a Separated Zone:

Screen	Setting	Description
P014	Add Separated Zone	<ul style="list-style-type: none">• Enables to add of a Separated Zone.• L2 is displayed for Separated Zone A – press OK.• Scroll to set the area of the Separated Zone and press OK.

Splicing the Perimeter Wire (as needed)

- Insert both wire ends into the leftmost and rightmost positions on the connector.
- Verify that the wires are fully inserted into the connector.
- Use a pair of pliers to press the button on top of the connector. The button should be fully pressed, without damaging the connector.

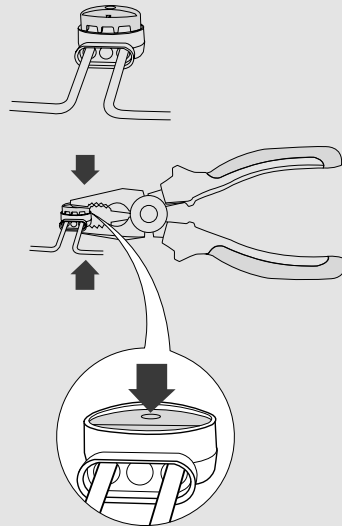

*A helpful video
is available
online*

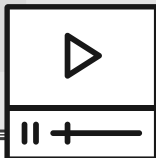

Well Done!

***Now relax, and let your
mower do the work.***

- ① ***Knowing your mower***
- ② ***Menu structure***
- ③ ***Automatic operation***
- ④ ***Manual operation***
- ⑤ ***Features - how to***
- ⑥ ***Periodic maintenance***
- ⑦ ***Troubleshooting***
- ⑧ ***FAQs***

1

Knowing your mower

In order to fully enjoy your mower, learn about its different parts and messages. Understanding how it works and “interacts” will lead to its smooth and easy operation.

External Parts

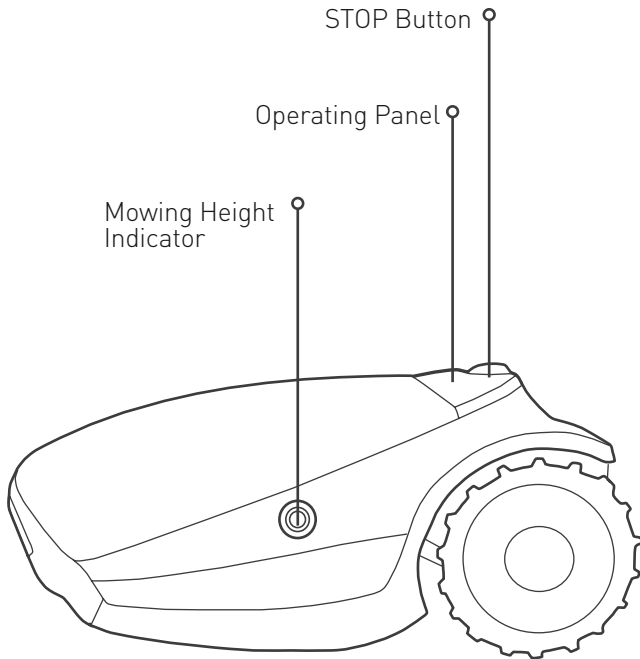

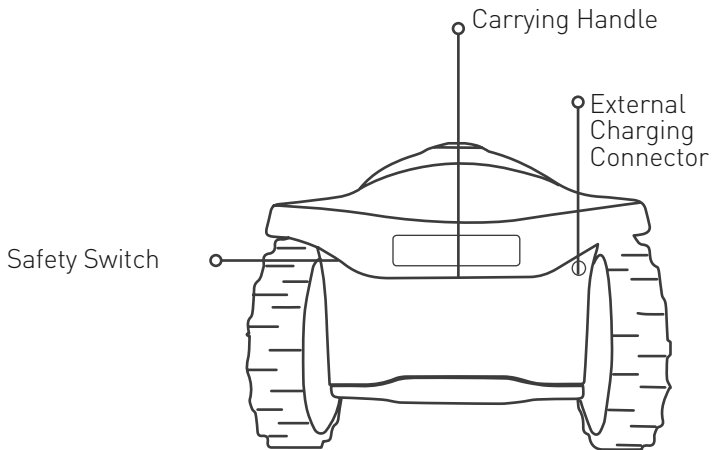
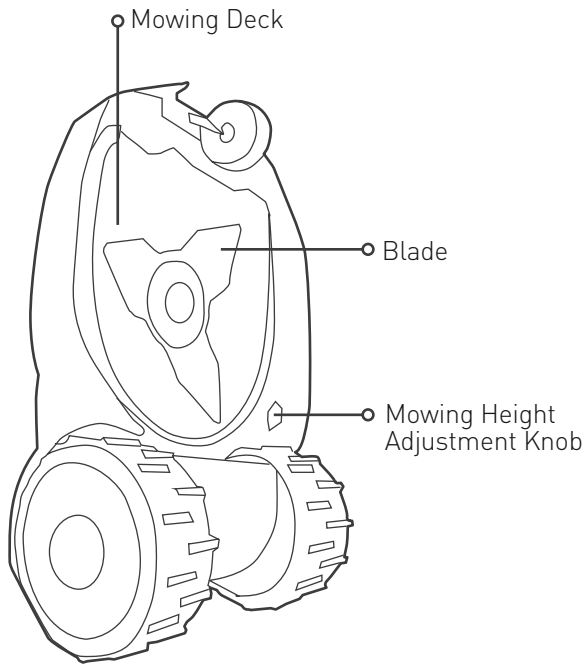

Operating Panel & Display

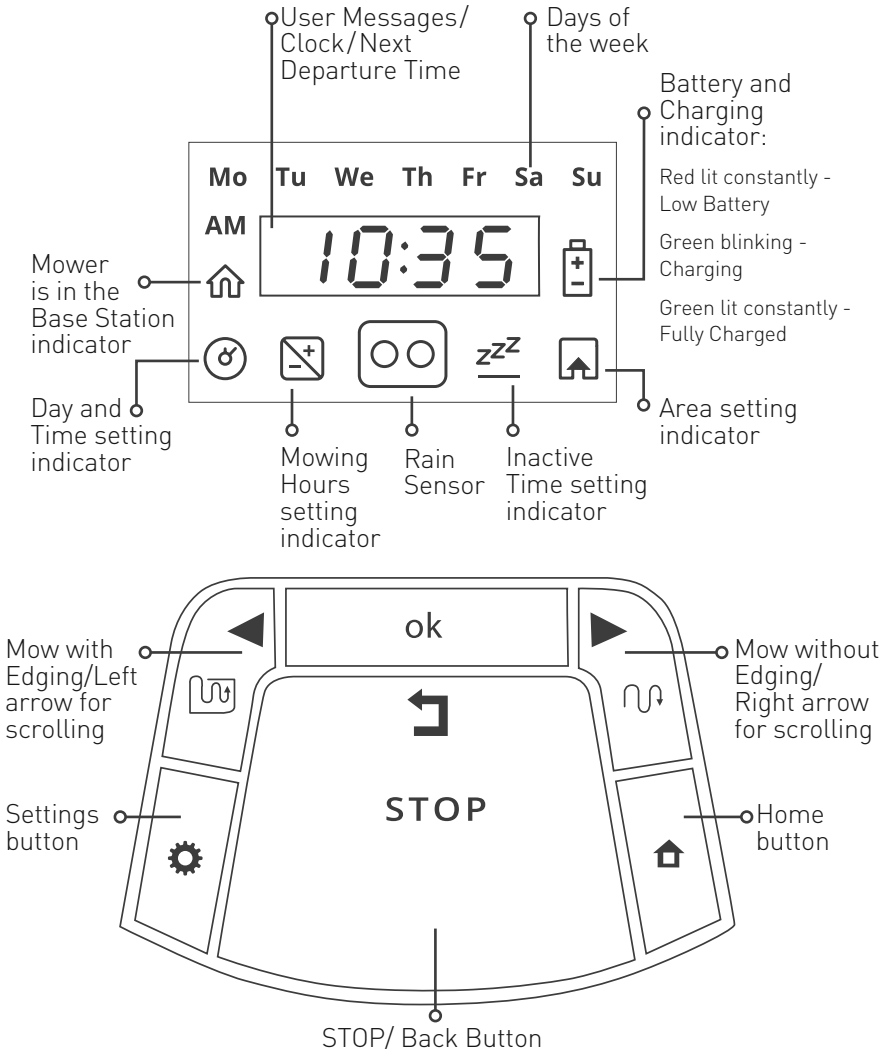

Base Station LED indication

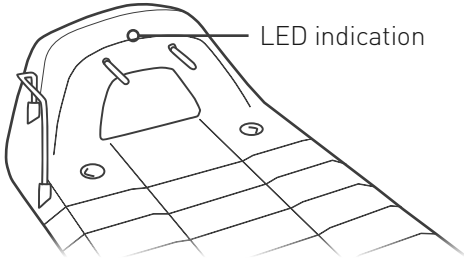

Indication	Meaning
Steady green	Perimeter wire signal is OK; the mower is inside the base
Blinking green	Perimeter wire signal is OK; the mower is outside the base
Blinking red fast	Perimeter wire is damaged or disconnected
Blinking red slow	Poor perimeter wire connection or the wire is too long
Steady red	Faulty power supply

2 Menu structure

For the full description of all menu items, please refer to our online Help Center.

Basic Settings

The Basic Settings are the most frequently used menu options. Each one of the Basic Settings has a dedicated icon on the mower's panel.

Press the "Settings" button. Every press on the "Settings" button will move between the following 4 menu options:

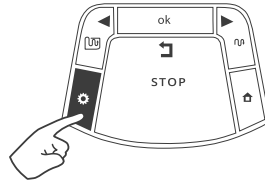

Day and Time

Set current Time and week Day. Update it every time the mower is switched on.



Mowing Hours

Add extra mowing time. See section 3 below.



Inactive Time

Set mowing-free times. See section 3 below.



Area

Set the area size of each zone of your lawn.



TIP

Some settings are defined per zone.

This is how zones are named:

- | | |
|-----------------------|-----------------|
| L1 – Main Zone | A1 – Sub-Zone 1 |
| L2 – Separated Zone A | A2 – Sub-Zone 2 |
| L3 – Separated Zone B | A3 – Sub-Zone 3 |

Advanced Settings

The Advanced Settings are additional menu options that are not changed very often.

Press **Settings**
for 3 seconds

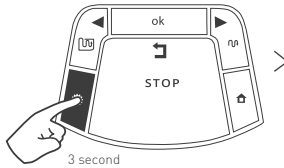

P001 is displayed



Use the arrow
to scroll

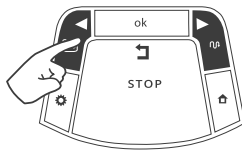

Press **OK** to select
the desired setting

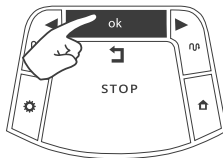

Setting	Description
P001	Mowing Frequency Select a higher value for more frequent mowing. See section 3 below.
P002	Islands On/Off Escape perimeter islands when searching for the base.
P003*	Near-Wire Following On/Off Drive to base at a dynamic distances from the lawn's edge to reduce wheel tracks.

[*] This setting is not applicable to models for lawns under 800 m²/8600 ft².

Setting	Description
P004*	Max Near-Wire Follow Distance Maximal allowed distance from the edge, when P003 is On.
P005*	Min Near-Wire Follow Distance Minimal allowed distance from the edge, when P003 is On.
P006*	Near Wire Follow Test Test the mower at the max distance set in P004.
P007	Rain Sensor On/Off Automatically halt operation in rainy weather.
P008	Rain Sensor Sensitivity Set higher value for higher sensitivity to rain.
P009	Edging On/Off Enable/disable automatic edge-mowing.
P010	Child Lock On/Off Lock the keypad to prevent accidental press. See section 5 further.
P011	Anti-Theft On/Off Enable and set a 4-digit PIN-code for protection. See section 5 below.
P012	Anti-Theft PIN-code Change and confirm new anti-theft PIN code. See section 5 below.
P013	Base Station On/Off Set an additional base for a separated zone.
P014	Add Separated Zone Define a new separated zone and set its area size.
P015	Remove Zone Delete a separated zone or a sub-zone.
P016	Sound On/Off Disable operating sounds.

(*) This setting is not applicable to models for lawns under 800 m²/8600 ft².

Setting	Description
P017	Mobile Communication System Enable GSM module accessory (if installed).
P018	Statistics On/Off Send operating statistics for diagnostics.
P019	Bluetooth Remote Control Pairing Pair Remote Control accessory with your mower.
P020	Last Termination Event Enable special debug mode (by a Service Station).
P021	Program On/Off Enable/Disable automatic operation by zone. See section 4 further.
P022	Add Sub-Zone Start the process of adding a sub-zone. Refer to the “Adding Sub Zones” section of the Installation Manual.
P023	Update Distance to Sub-Zone Update the distance to the Sub-Zone’s entry point. This menu option is only shown if a Sub-Zone is defined.
P024	SmartMow On/Off Increase mowing efficiency. May be less efficient with particular lawn shapes.
P025	SmartMow Edge Overlap Optimize SmartMow mode for your lawn.
P026	Turbo Mow On/Off Enable faster and stronger cut. When the mowing cycle is completed, this feature is set to off automatically.
P027	RoboHome On/Off Allow proper rain detection when RoboHome is installed.
P028	External Base Enable and set the distance of an external base installation.

3

Automatic operation

Learn how to configure automatic operation and manually bypass/override it when needed.

- The Area size setting automatically determines the required mowing time for your lawn - the duration of a “Mowing Cycle”
- The mower usually performs several consecutive mowing operations until it completes a full Mowing Cycle
- Each mowing operation starts at predetermined times, once the mower is fully charged
- You can restrict automatic operation at particular times via the Inactive Time setting
- Once a Mowing Cycle is completed, the mower will stay in the Base Station until the next cycle begins
- The interval between mowing cycles is defined by the Mowing Frequency setting
- If required, extra mowing time can be added via the Mowing Hours setting to improve mowing results.

Tell the mower how often to mow

Mowing Frequency* controls the periodicity of mowing cycles. The higher the frequency, the more frequently your lawn will be mowed and vice versa.

Press **Settings** for 3 second. P001 will be displayed.

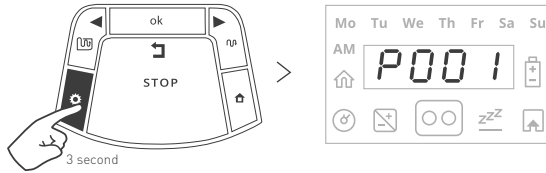

Press **OK** to get in

Use the arrows to select the desired mowing frequency:

- 01 - LOW** (one mowing cycle per week)
- 02 - MEDIUM** (two mowing cycles per week)
- 03 - HIGH** (the lawn is mowed daily)

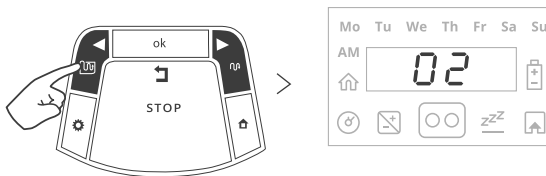

Press **OK** to confirm.

*This option is only available for zones with a Base Station.

When you need extra mowing time

If the mowing results are not satisfactory, the Mowing Hours setting allows adjusting (by percentage) the mowing time allocated for your lawn size.

Press **Settings** twice until the Mowing Hours indication is lit.

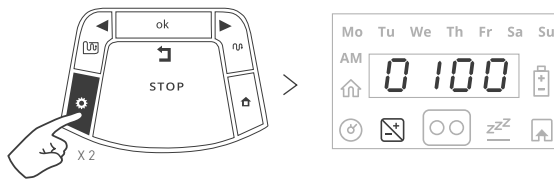

Use the scrolling arrows to adjust the allocated mowing time (in %) and press **OK** to confirm.

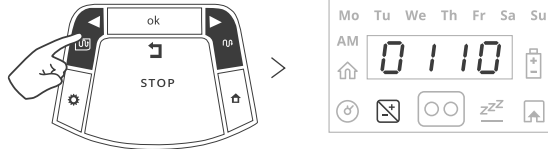

The default value of this setting is 0100 (100%); it can be changed from 0050 (50%) to 0150 (150%).

Example: A value of 110% means that the mower will run 10% more time on your lawn.

To set specific “mowing free” days and hours

You can set specific days or specific hours during a day, when you don't want the mower to work on your lawn.

For example, during weekends or during hours, when the children usually play in the lawn.

To set such “mowing free” times, press **Settings** three times.

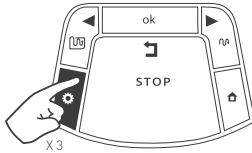

Until the **Inactive Day(s)** will constantly lit.

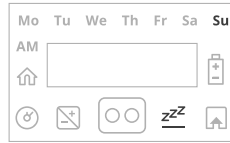

Press **OK**.

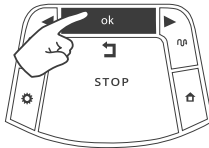

'Mo' will start blinking.

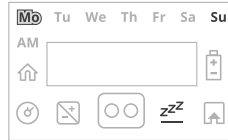

Press the **RIGHT** or **LEFT** arrows to scroll to the days you want to set as 'Inactive'.

Press **OK** to toggle between “Active” and “Inactive” options for that day.

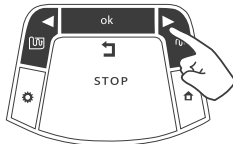

The LED is lit – 'Inactive Day' (mower will stay in the Base Station all day). The LED is off – available day for mowing.

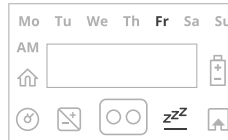

Scroll through all the days to the right, until the 'Inactive Hours' will start blinking.

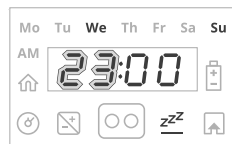
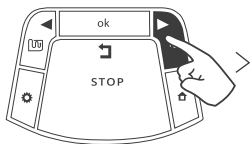

Set the time, at which the Inactive Hours start and press **OK**.

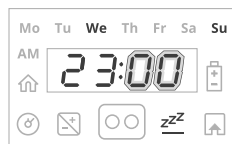
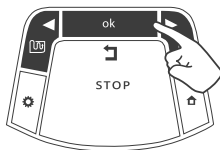

Set the time at which the Inactive Hours end and press **OK**.

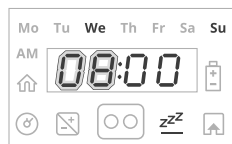
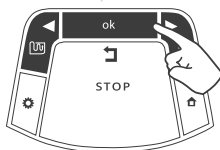

Plan mowing times for safety.

Always make sure that the mower is set to work when the lawn is vacant. In addition, always set "mowing-free" times when people (especially children) or pets may be found in vicinity.



TIPS

- The mower will not operate during the Inactive Hours throughout all days of the week.
- If too many days/hours have been deactivated relative to the zone area, then "E8" (Decrease Inactive Time) will be displayed - you need to decrease the amount of inactive time so that the mower will have enough time to mow your lawn.
- To set the "Inactive Hours" to "Off" set the same time for the start and the end (i.e.: 00:00 to 00:00).

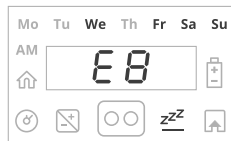

Pause automatic operation for a specific zone

If you wish to pause automatic operation in a particular zone of your lawn, you may do so via the Program On/Off menu.

Press **Settings** for 3 seconds. P001 will be displayed.

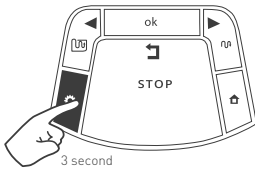

Use the arrows to scroll to menu **P021**.

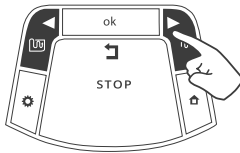

Press **OK**.

Use the arrows to scroll to the desired zone:
L1 – Main Zone
A1 – Sub-Zone 1
A2 – Sub-Zone 2
A3 – Sub-Zone 3
ALL – Entire lawn

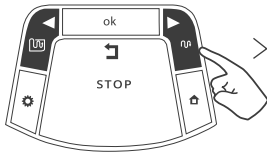

Press **OK** to select

Toggle between ON/OFF.

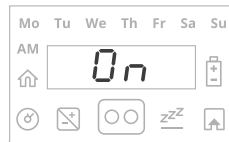

Press **OK** to confirm.

When Program is set to Off in a particular zone, the mower will skip the operation in that zone, but will continue to mow the edge of the entire lawn anyway.

4

Manual operation

Manual Operation is used when you want to start a mowing operation regardless of the mowing schedule.

Press any button to show the display.

If the battery is fully charged, the start time of the next operation is displayed, otherwise the current day and time are displayed.

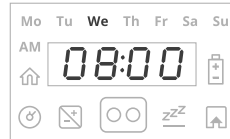

Operation Mode	Mowing with Edge	Mowing without Edge
Child Lock is Off	<p>Press the LEFT arrow once.</p>	<p>Press the RIGHT arrow once.</p>
Child Lock is On	<p>Press the LEFT arrow, then press OK.</p>	<p>Press the RIGHT arrow, then press OK.</p>



TIP

If a Sub-Zone is defined, L1 (Main Zone) will be displayed when you choose an operating mode. Use the arrows to scroll and choose the required zone to be mowed and press OK.

5 Features - how to

Adjust the cutting height (15-60 mm/0.6-2.4") of the mower by turning the cutting height adjustment knob:

- To raise the cutting height, turn clockwise.
- To lower the cutting height, turn anticlockwise
- The cutting height is displayed at the side of the mower.

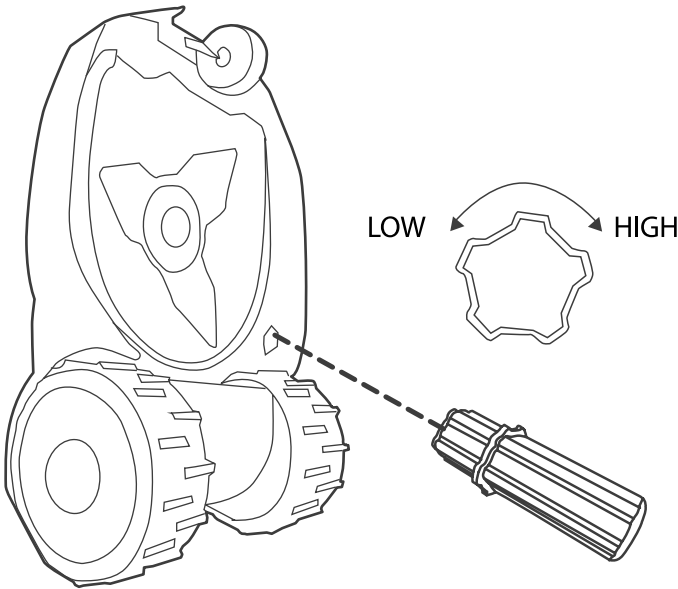

Child Lock

If you wish to prevent accidental press by children of the operating buttons on your mower, you may do so via the Child Lock On/Off menu.

Press **Settings** for 3 seconds. P001 will be displayed.

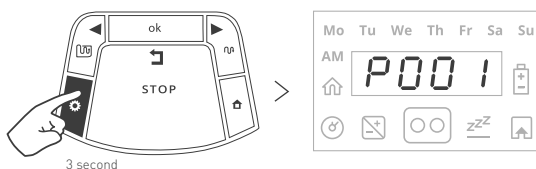

Use the arrows to scroll to menu **P010**.

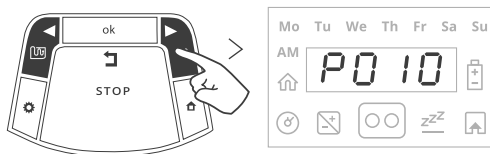

Press **OK**.

Toggle between ON/OFF.



Press OK to confirm.



TIP

If the Child Lock is set to 'On', to operate the mower, first press one of the operating mode buttons and then press OK to confirm.

Anti-Theft feature

The Anti-Theft feature sets off an alarm in the event of unintended removal of the mower from its designated area. By default, Anti-Theft is turned Off. To turn Anti-Theft On for the first time:

Press **'Settings'** for 3 seconds. P001 will be displayed.

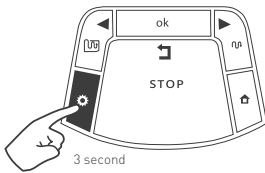

Use the arrows to scroll to menu **P011**.

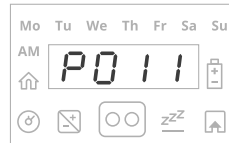
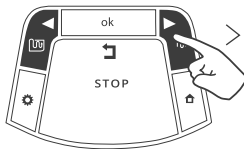

Press **OK**.

Select **ON**.



Press **OK** to confirm.

Choose a PIN code of 4 digits.

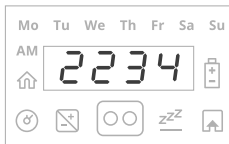
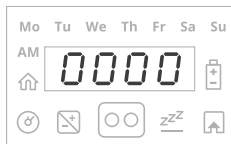



- Select a number you can remember. Write it down in the dedicated place at the end of this manual.
- The Anti-Theft system will automatically lock the mower, if there is no user activity (button pressing or mobile app's connection) for 30 minutes.
- When the Anti-Theft system is activated, 0000 will be displayed. Enter your 4-digit code to deactivate the Anti-Theft feature.
- If the code is not entered, then the message changes to U062 ("Alarm will soon be activated"). Enter the code, otherwise the alarm will start.



6

Periodic maintenance



WARNING

Severe injury and damage hazard!

Always turn the Safety Switch off before lifting the mower. The blade is very sharp. It can cause severe cuts or lacerations. Always wear heavy work gloves when working with or around the blades. NEVER use a damaged or broken blade. NEVER sharpen the blade manually.

Once a month:

- Inspect the underside of the mower. Clean if necessary. Carefully scrape the collected grass debris (using a small stick or similar object) from under the mowing deck.
- Check the Perimeter Wire and add pegs where it is loose and not tight to the ground. In case of seasonal changes in the lawn, make sure to adjust the wire accordingly.
- Inspect the Base Station, clean it from mud and debris to allow proper docking.



IMPORTANT!

NEVER use a high - pressure water to clean the mower. Liquids can damage components. Use only a damp or wet cloth to wipe the surface clean after scraping.

To allow better maintenance and to keep your mower in good condition, it is recommended to take it to a certified dealer for service prior to winter storage.

7

Troubleshooting

Message Displayed	Probable Cause / Event	Corrective Action
E1 "Stuck In Place"	The mower got stuck in place. It cannot continue driving.	Check the ground for holes or indentations. Fill it with some earth.
		Check if the Perimeter Wire is not too close to the edge. Move the wire towards the inner side of the lawn.
E2 "Cross Outside"	The Perimeter Wire is too close to the edge.	Move the wire towards the inner side of the lawn.
	The lawn slope near the edge is too big and causes the mower to slip outside.	Do not include areas with very steep slopes.
	The lawn's edge is too bumpy.	Fill holes and pits along the edge till level with the ground.
E3 "No Wire Signal"	The Power Supply is unplugged or there is a temporary power cut.	Make sure the Power Supply is connected to the mains supply.
	Signal generator may need to be restarted.	Disconnect the Power Supply from the mains supply and reconnect after 10 seconds.
	The Perimeter Wire is not connected to the Base Station.	Check the connection of the Perimeter Wire to the Base Station. Make sure the plot connector is properly mounted.
	The Perimeter Wire is cut.	Check for cuts in the Perimeter Wire.
E4 "Check Power"	There is a temporary power cut.	Check main power supply to the Power Supply.
	The Power Supply is not plugged in properly.	Confirm the Power Supply is plugged in.
	There is no charging source detected.	Clean the charging contacts on the Base Station and verify proper connection of the Base Station to the Power Supply.
E5 "Check Mow Height"	The mowing system is in overload due to very tall grass or an obstacle that is stuck or wrapped around the blade.	Switch off the Safety Switch and inspect the blades. Remove any foreign object or excessive clogging inside the mowing deck.
		Raise the mowing height and switch the TurboMode on.

Message Displayed	Probable Cause / Event / Meaning	Corrective Action
E8 "Decrease Inactive Time"	Too many Inactive Days and/or Hours have been set for your lawn area.	Decrease the number of Inactive Days and/or the number of Inactive Hours.
	Mowing Frequency is too high for current settings of Inactive Time.	Decrease Mowing Frequency. See "Tell your mower how often to mow".
	Area setting is too high for current settings of Inactive Time.	Decrease area setting.
E9 "See Troubleshooting in Manual"	E 9 is displayed for all other error messages that are not listed above.	Press the Right arrow to receive the stop reason number and refer to our online Help Center.
U009	Wait for the operational data to be sent via the GSM module.	No action is required. As soon as the operational data has been sent, charging will start. This may take a couple of minutes.
U025	Switch off before lifting.	It is required to switch Off the System Switch before lifting and carrying the mower.
U032	The mower is connected to charging, but switched off.	Switch the System Switch to 'On' to allow charging.
U086	Waiting for the perimeter signal.	Check all power cable connections. The mower will resume automatically.
U087	The mowing motor has been overloaded for too long.	No action required. The mower will resume automatically once cooled down.

8

Frequently asked questions



Mower does not dock properly and sometimes misses Base Station's contacts

The entrance to the Base Station is not flat. Fill some ground to flatten the lawn around the Base Station to allow smooth entrance. Make sure the Perimeter Wire is straight and centered or shifted 4-5 cm to the left in case of External Installation all the way under the Base Station. Clean the Front Wheel and make sure it rotates freely on its axis. Make sure that the base Station is placed on a relatively level ground.



Poor quality mowing

The blade may be dull. Switch off the Safety Switch, put heavy gloves and inspect the blade. Replace the blade if needed. The grass may be wet. For the best cut, operate your mower when the grass is dry. It is recommended not to mow in the early morning hours.



Patchy and uneven mowing

Minimize Inactive Time for faster Mowing Cycle and even mowing result. If it is the fast growing season - reduce the time between mowing cycles via the **Mowing Frequency** setting. Increase the allocated mowing time via the **Mowing Hours** setting to compensate for lawn's shape complexity.



Mower does not depart from base for a long time

Press and hold the 'Home' button for 1 second while the mower is in the Base Station. The non-depart reason code will be displayed for 3 seconds. Refer to our Help Center online for a detailed description of non-depart codes.



Mower operates at wrong times

Verify that the time on the mower is set correctly. The time and Day setting needs to be refreshed every time the mower is switched on.

WOLF-Garten ist eine Marke der MTD Products Aktiengesellschaft
WOLF-Garten is a trademark of MTD Products Aktiengesellschaft

Industriestraße 23 • 66129 Saarbrücken • Germany
Fon/Phone +49 6805 79-202 • Fax +49 6805 79-442
www.WOLF-Garten.com • info@WOLF-Garten.com



www.WOLF-Garten.com